



175/220 TYPE

# ALUMINUM PERGOLA

## PRODUCT ATLAS

Aluminium Alloy Shutter Pavilion  
Product Manual



Aluminium alloy



Wireless remote control



Wind resistance



Double blade



Support customization



Water proof



DESIGNED TO PERFORM.  
BUILT TO LAST.

Engineering comfort. Enhancing outdoor living.

PARALLEL LINES.  
BETTER SPACES.

## PRODUCT INTRODUCTION

Parallel lines.  
Perfect outdoor living.



It is a new type of sunshade canopy with excellent sunshade, heat insulation, rain proof, wind resistance, stable and durable functions. The precise louver structure technology and drainage system enable the blades to completely block the light and rain after closing, and resist the wind environment of 100km/h to minimize the interference of external weather on the sunshade space. The opening and closing angles of the blades are controlled by the flip of the blades to adjust the light and ventilation. It can also be combined with the lamp belt, ceiling fan and windproof curtain to form an ecological sunshine room, so that you and your family can enjoy high-quality outdoor comfortable life.



### Aluminum Pergola

CLOSED STATE

OPEN STATE

WATER TANK

BUILT-IN LIGHT STRIP



Fully closed for complete shade and rain protection.



Adjustable blades for optimal sunlight and airflow.



Integrated water tank collects rainwater efficiently.



Built-in LED lighting for a comfortable ambiance.



Aluminium alloy



Wireless remote control



Wind resistance



Double blade



Support customization



Water proof

# PRODUCT ADVANTAGE

Engineered for performance.  
Built for all seasons.

## 01 GREAT OPEN ANGLE



Blade opening and closing angle up to 150°, according to the demand to adjust shading degree and air intake volume.

## 02 DOUBLE BLADE WITH FLUME



The louvers are equipped with side drainage systems. Even if they are opened after a heavy rain, the water will flow from the blades into the tank without drip.

## 03 HIDDEN DRAINAGE



The concealed drainage system allows rainwater to drain directly from the top of the louvers into the columns and then out through underground drainage channels.

## 04 FLAT LOAD 100 KG



Can effectively prevent the surrounding rain splash, the top surface can resist the duration of 2 minutes, the intensity of up to 40–50 ml/s/ square meters of rain. Snow pressure resistance up to 110 kg/square meter.

## 05 ALUMINUM ALLOY & POWDER COATING

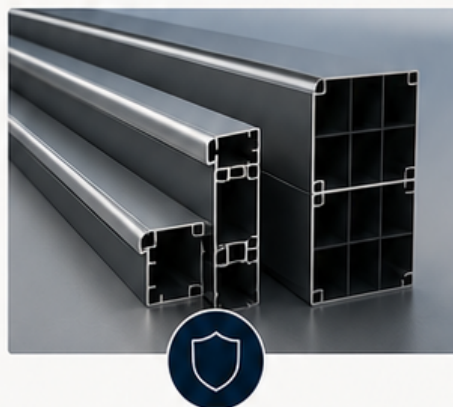

Made of high-quality 6063 aluminum alloy, set strong wind pressure resistance, corrosion resistance, deformation resistance in one; Surface high density powder spraying, no corrosion, no maintenance, safety and environmental protection, 20 years do not fade.

## 06 DUAL DRAINAGE SYSTEM



Top surface and side drainage combined design to ensure efficient drainage, keep your outdoor space dry and comfortable all the time.



Aluminium alloy



Wireless remote control



Wind resistance



Double blade



Support customization



Water proof

# 175 TYPE

ELECTRIC / MANUAL MODEL

**DESIGNED FOR ELEGANCE.  
BUILT FOR PERFORMANCE.**

The 175 Type pergola offers a perfect balance of strength and style. Compact in design yet powerful in performance, it's ideal for patios, terraces and private outdoor spaces. Engineered with precision for durability, weather resistance and everyday comfort.



A SINGLE BLADE  
CAN DO  
**4-5** METERS



BLADE

- Width: 220mm
- Thickness: 40mm
- Profile Thickness: 2.0mm



BEAM

- Width: 220mm
- Thickness: 2.5mm
- Water Tank Thickness: 1.5mm



COLUMN

- Size: 150 × 150mm
- Optional Size: 180 × 180mm
- Profile Thickness: 2.5 - 3.0mm



MATERIAL

High-quality 6063 aluminum alloy with powder coating.

## PROFILE SECTION

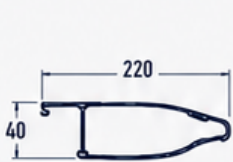

▲ BLADE

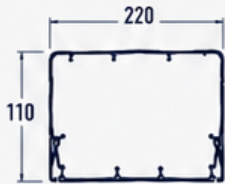

▲ BEAM

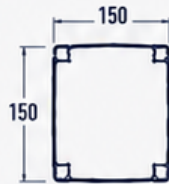

▲ COLUMN

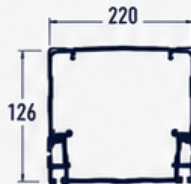

▲ WATER TANK

## BEAM SINK SEPARATED DESIGN

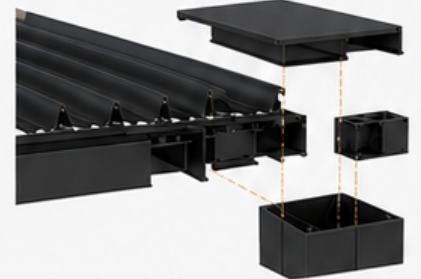

**HIGH LOAD CAPACITY**  
Engineered to withstand heavy loads up to 100 kg/m<sup>2</sup>.



**WIND RESISTANCE**  
Withstands wind speeds up to 120km/h for safe outdoor living.



**WATERPROOF DESIGN**  
Integrated drainage system keeps rainwater away and your space dry.



**SMART CONTROL**  
Electric or manual operation with remote control for convenience.



**SUPPORT CUSTOMIZATION**  
Multiple sizes and configurations available to meet your needs.

SPECIFICATION TABLE

ITEMS	175 TYPE	220 TYPE
Single Blade Can Do	4 – 5 meters	4 – 5 meters
Blade Width	175mm	220mm
Blade Thickness	40mm	40mm
Beam Width	175mm	220mm
Beam Thickness	2.5mm	2.5mm
Column Size	150 × 150mm	150 × 150mm
Column Thickness	2.5 – 3.0mm	2.5 – 3.0mm
Water Tank Thickness	1.5mm	1.5mm
Material	High-quality 6063 aluminum alloy with powder coating	
Control System	Electric / Manual operation with remote control (Electric model)	
Optional Accessories	LED Light Strip / Windproof Curtains / Heating / Rain & Wind Sensors	
Wind Resistance	Up to 120km/h	
Snow Load Capacity	Up to 100 kg/m <sup>2</sup>	

COLOUR OPTIONS



Custom colours available upon request.

COMBINATION ASSEMBLY

Multiple units can be combined side-to-side or front-to-back using shared columns, allowing for larger coverage and flexible space configuration.



## PERGOLA MODEL CATEGORIES

Parallelism pergolas are available in a range of design styles to suit different architectural themes and personal preferences.

A SINGLE BLADE CAN DO  
**4-5 / 4-5 METERS**  
 (175 TYPE / 220 TYPE)

### SIMPLE TYPE

Clean lines and minimalist design for modern spaces. Perfect for patios, balconies and small gardens.



175 TYPE	220 TYPE
Single Blade Can Do 4 – 5 meters	Single Blade Can Do 4 – 5 meters
COLUMN SIZE 150 × 150mm	COLUMN SIZE 150 × 150mm
2.5 – 3.0mm THICKNESS	2.5 – 3.0mm THICKNESS

### EUROPEAN STYLE

Timeless European design with refined details. Enhances the elegance of villas and courtyards.



175 TYPE	220 TYPE
Single Blade Can Do 4 – 5 meters	Single Blade Can Do 4 – 5 meters
COLUMN SIZE 150 × 150mm	COLUMN SIZE 150 × 150mm
2.5 – 3.0mm THICKNESS	2.5 – 3.0mm THICKNESS

### LUXURY TYPE

Bold structure with premium finishes. Designed for luxury residences and high-end commercial areas.



175 TYPE	220 TYPE
Single Blade Can Do 4 – 5 meters	Single Blade Can Do 4 – 5 meters
COLUMN SIZE 150 × 150mm	COLUMN SIZE 150 × 150mm
2.5 – 3.0mm THICKNESS	2.5 – 3.0mm THICKNESS

### TOP-LEVEL TYPE

Top-tier performance and sophisticated appearance. Built for the most demanding projects.



175 TYPE	220 TYPE
Single Blade Can Do 4 – 5 meters	Single Blade Can Do 4 – 5 meters
COLUMN SIZE 150 × 150mm	COLUMN SIZE 150 × 150mm
2.5 – 3.0mm THICKNESS	2.5 – 3.0mm THICKNESS



**HIGH LOAD CAPACITY**  
 Engineered to withstand heavy loads up to 100 kg/m<sup>2</sup>.

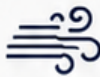

**WIND RESISTANCE**  
 Withstands wind speeds up to 120km/h for safe outdoor living.



**WATERPROOF DESIGN**  
 Integrated drainage system keeps rainwater away and your space dry.



**SMART CONTROL**  
 Electric or manual operation with remote control for convenience.



**SUPPORT CUSTOMIZATION**  
 Multiple sizes and configurations available to meet your needs.

## NIGHT LIGHT EFFECT

Integrated LED lighting system creates a warm and comfortable ambiance for evening gatherings and outdoor living.

Hidden installation, uniform illumination and low energy consumption.

### LED LIGHT STRIP



Warm White / Cool White  
Optional



IP65 Waterproof



> 50,000 Hours Lifespan



Low Energy Consumption



Concealed LED Light Strip

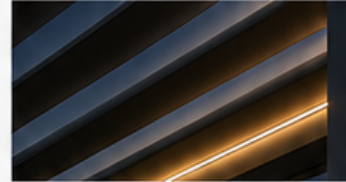

Uniform & Soft Illumination

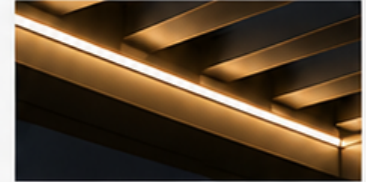

Energy Saving & Durable

## WINDPROOF CURTAINS

Top-to-bottom zip track design provides excellent wind resistance, rain protection and privacy.

Smooth operation and high-strength fabric for long-lasting performance.

### CURTAIN FEATURES



Wind Resistance  
Up to 100km/h



Waterproof & UV Resistant



Enhanced Privacy



Smooth Zip Track System



Heavy-duty Zip Track

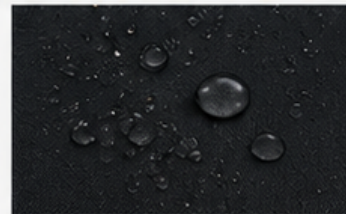

Waterproof Fabric



Secure & Windproof



**HIGH LOAD CAPACITY**  
Engineered to withstand heavy loads up to 100 kg/m<sup>2</sup>.

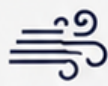

**WIND RESISTANCE**  
Withstands wind speeds up to 120km/h for safe outdoor living.



**WATERPROOF DESIGN**  
Integrated drainage system keeps rainwater away and your space dry.



**SMART CONTROL**  
Electric or manual operation with remote control for convenience.



**SUPPORT CUSTOMIZATION**  
Multiple sizes and configurations available to meet your needs.

## FLEXIBLE INSTALLATION FOR ANY SPACE

Multiple installation methods to match different environments and structural requirements. Secure, stable and built to last.



**PROFESSIONAL INSTALLATION RECOMMENDED**

Ensure the pergola is installed on a level surface with a solid structure capable of supporting the load.

### 1. FREESTANDING INSTALLATION



Independent structure with four columns. Can be installed anywhere in your outdoor space.

### 2. WALL-MOUNTED INSTALLATION



Mounted to an existing wall with front columns. Ideal for balconies, patios and terraces.

## BASE FIXING OPTIONS

### STANDARD BASE PLATE

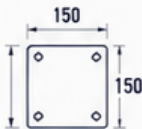

150 x 150mm Base Plate

Fix with expansion bolts on concrete floor.

### HIDDEN BASE PLATE

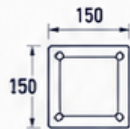
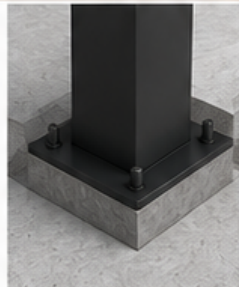

150 x 150mm Hidden Base

Concealed installation for a clean and seamless look.

### GROUND ANCHOR FIXING

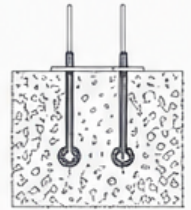

Suitable for soft ground or areas without concrete flooring.

## INSTALLATION NOTES

- Ensure the installation surface is level and solid.
- Use expansion bolts for concrete surfaces (M10 x 100mm recommended).
- Two or more people are recommended for installation.
- Check all components are secure and tighten all screws after installation.
- Follow local building codes and wind load requirements.

## OVERALL INSTALLATION DIMENSIONS (REFERENCE)

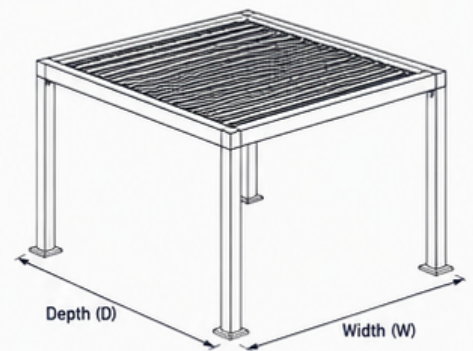
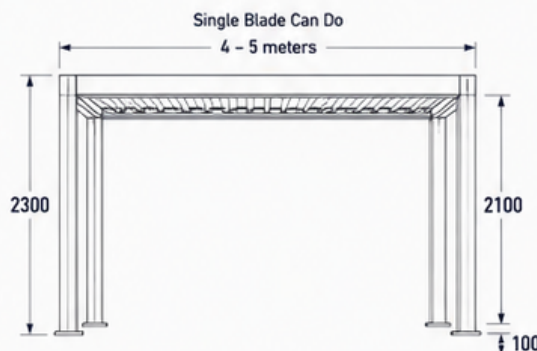

Note: Dimensions are for reference only. Final installation should be based on actual site conditions.



**HIGH LOAD CAPACITY**  
Engineered to withstand heavy loads up to 100 kg/m<sup>2</sup>.

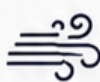

**WIND RESISTANCE**  
Withstands wind speeds up to 120km/h for safe outdoor living.



**WATERPROOF DESIGN**  
Integrated drainage system keeps rainwater away and your space dry.



**SMART CONTROL**  
Electric or manual operation with remote control for convenience.



**SUPPORT CUSTOMIZATION**  
Multiple sizes and configurations available to meet your needs.

## MAINTENANCE GUIDE

Minimal maintenance is required to keep your pergola looking and performing its best for years to come.

**REGULAR CLEANING**  
Clean the aluminum surfaces with mild soap and water to remove dust and dirt.

**AVOID HARSH CHEMICALS**  
Do not use abrasive cleaners or solvents that may damage the powder coating.

**CHECK FIXINGS**  
Periodically inspect and tighten screws and bolts to ensure stability and safety.

**KEEP DRAINS CLEAR**  
Ensure water drainage channels are free from leaves and debris for proper water flow.

**WINTER CARE**  
In heavy snow regions, remove excess snow from the blades to reduce load.

## OPTIONAL ACCESSORIES

Enhance comfort, functionality and style with our range of optional accessories.

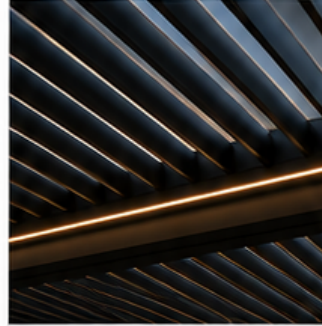

### LED LIGHT STRIP

Integrated LED lighting for a warm and elegant ambiance.



### WINDPROOF CURTAINS

Protects against wind, rain and UV while adding privacy.



### HEATER

Enjoy your outdoor space all year round with adjustable heaters.



### POWER OUTLET

Weatherproof power outlets for convenient outdoor use.



### DRAINAGE SYSTEM

Built-in gutter system efficiently diverts rainwater.



### SMART CONTROL

Remote control operation for blades, lighting and accessories.

## OUR PROJECTS

From private residences to commercial spaces, our pergolas bring value and elegance to every project.



### PRIVATE RESIDENCE

Modern outdoor living space.



### ROOFTOP TERRACE

Stylish comfort with a view.



### RESTAURANT

Enhancing guest experience.



### HOTEL & RESORT

Luxury and relaxation combined.



**HIGH LOAD CAPACITY**  
Engineered to withstand heavy loads up to 100 kg/m<sup>2</sup>.



**WIND RESISTANCE**  
Withstands wind speeds up to 120km/h for safe outdoor living.



**WATERPROOF DESIGN**  
Integrated drainage system keeps rainwater away and your space dry.



**SMART CONTROL**  
Electric or manual operation with remote control for convenience.



**SUPPORT CUSTOMIZATION**  
Multiple sizes and configurations available to meet your needs.

## DESIGNED TO MATCH YOUR VISION

Personalize your pergola to complement your space and style. Choose from a variety of colors, finishes and configurations to create a look that is uniquely yours.



### STANDARD FRAME COLORS

High-quality powder-coated finishes for long-lasting beauty and protection.

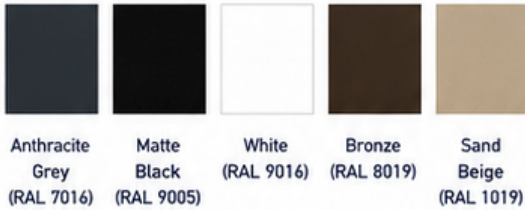

Anthracite Grey (RAL 7016)    Matte Black (RAL 9005)    White (RAL 9016)    Bronze (RAL 8019)    Sand Beige (RAL 1019)

**CUSTOM COLORS AVAILABLE**  
We can match any RAL color to suit your project needs.

### Louver Finishes

Choose the perfect finish for the louver blades.



Powder Coated (Smooth)



Wood Grain Finish (Heat Transfer Print)

### CONFIGURATION OPTIONS

Flexible configurations to fit your space and functional needs.



**SINGLE MODULE**  
Compact and efficient for small spaces.



**MULTI-MODULE**  
Combine modules for larger coverage.



**WALL-MOUNTED**  
Space-saving solution attached to existing walls.



**FREESTANDING**  
Independent structure with 360° access.

### ADDITIONAL ACCESSORIES



### PREMIUM FINISH DETAILS



Precision Engineering



Hidden Fasteners for Clean Look

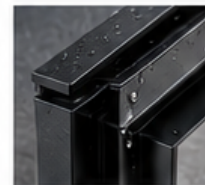

Weather Sealed Components



Smooth Powder Coated Surface

**BUILT TO LAST. DESIGNED FOR YOU.**  
Every detail, every finish, every option—crafted for performance, built for beauty.

YOUR SPACE. YOUR STYLE. OUR EXPERTISE.

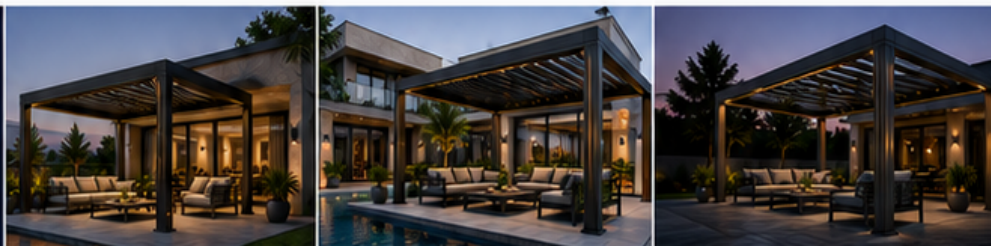

**HIGH LOAD CAPACITY**  
Engineered to withstand heavy loads up to 100 kg/m<sup>2</sup>.



**WIND RESISTANCE**  
Withstands wind speeds up to 120km/h for safe outdoor living.



**WATERPROOF DESIGN**  
Integrated drainage system keeps rainwater away and your space dry.



**SMART CONTROL**  
Electric or manual operation with remote control for convenience.



**SUPPORT CUSTOMIZATION**  
Multiple sizes and configurations available to meet your needs.

## ENGINEERED FOR PERFORMANCE

Our pergolas are built with premium materials and precision engineering to ensure strength, durability and long-lasting performance in all climates.

### SPECIFICATIONS

Frame Material	Extruded Aluminum (6063-T5)
Louver Blade Material	Aluminum (6063-T5)
Finish	Powder Coated
Standard Colors	Anthracite Grey, Matte Black, White, Bronze, Sand Beige
Custom Colors	Available (RAL Matching)
Max Width (Single Module)	4500 mm
Max Projection (Single Module)	6000 mm
Height (Standard)	2300 mm (Custom Heights Available)
Wind Resistance	Up to 120 km/h*
Snow Load Capacity	Up to 100 kg/m <sup>2</sup> *
Waterproof Rating	IP65 (Integrated System)
Operating Temperature	-30°C to +60°C
Louver Rotation Angle	0° - 120°
Control System	Remote Control / Wall Switch / Smart App Integration
Certification	CE, ISO 9001, SGS Tested

\*May vary based on size and installation conditions.

### STRUCTURAL DETAILS

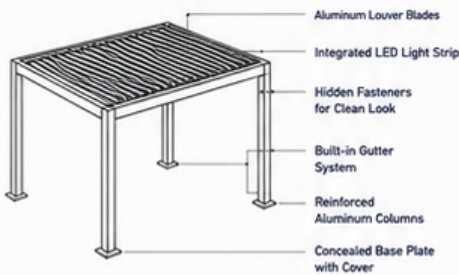

### BUILT FOR ALL SEASONS

Designed to withstand the elements and provide comfort all year round.



**WIND RESISTANT**  
Engineered to endure strong wind conditions up to 120 km/h.



**SNOW LOAD**  
Strong enough to support snow loads up to 100 kg/m<sup>2</sup>.



**WATERPROOF**  
Integrated gutters and drainage keep water away and your space dry.



**UV PROTECTION**  
Powder coated finish resists UV rays, fading and corrosion.



### SMART CONTROL OPTIONS

Operate your pergola with ease and convenience.

- ✔ Remote control operation
- ✔ Wall switch control
- ✔ Smartphone app integration
- ✔ Voice control compatible (with smart home systems)
- ✔ Adjust louvers, lighting and accessories effortlessly



### QUALITY YOU CAN TRUST

Premium materials, advanced engineering and rigorous testing ensure your pergola stands strong and looks beautiful for years to come.



PREMIUM MATERIALS



PRECISION ENGINEERING



RIGOROUS TESTING



LONG-LASTING PERFORMANCE



**HIGH LOAD CAPACITY**  
Engineered to withstand heavy loads up to 100 kg/m<sup>2</sup>.



**WIND RESISTANCE**  
Withstands wind speeds up to 120km/h for safe outdoor living.



**WATERPROOF DESIGN**  
Integrated drainage system keeps rainwater away and your space dry.



**SMART CONTROL**  
Electric or manual operation with remote control for convenience.



**SUPPORT CUSTOMIZATION**  
Multiple sizes and configurations available to meet your needs.

## FREQUENTLY ASKED QUESTIONS



**Q: WHAT IS A PARALLELISM PERGOLA MADE OF?**

A: Our pergolas are made from high-quality extruded aluminum (6063-T5) with a powder-coated finish for maximum durability and weather resistance.



**Q: IS THE PERGOLA WATERPROOF?**

A: Yes, the louvered roof system and integrated gutter design effectively direct rainwater away to keep your space dry.



**Q: CAN THE LOUVERS BE ADJUSTED?**

A: Absolutely. The louvers can be adjusted from 0° to 120° to control sunlight, ventilation and shade.



**Q: IS INSTALLATION DIFFICULT?**

A: Our pergolas are designed for easy installation with pre-drilled components and clear instructions. Professional installation is recommended.



**Q: DO YOU OFFER CUSTOM SIZES?**

A: Yes, we offer a range of standard sizes and can also customize dimensions and configurations to meet your specific project requirements.



**Q: WHAT IS THE WARRANTY?**

A: We stand behind our products with a 5-year limited structural warranty and 2-year warranty on components and finishes.



## READY TO ELEVATE YOUR OUTDOOR SPACE?

Our team is here to help you find the perfect pergola solution for your project.



EXPERT ADVICE



CUSTOM SOLUTIONS



RELIABLE SUPPORT

## GET IN TOUCH



+1 (888) 123-4567



info@parallelism.com



www.parallelism.com



1234 Building Way, Suite 100  
Los Angeles, CA 90017  
United States



**DESIGNED FOR LIFE.  
BUILT FOR MEMORIES.**

Thank you for considering Parallelism for your outdoor living needs. We look forward to being a part of your next project.

*Let's build better spaces. Together.*



**HIGH LOAD CAPACITY**  
Engineered to withstand heavy loads up to 100 kg/m<sup>2</sup>.



**WIND RESISTANCE**  
Withstands wind speeds up to 120 km/h for safe outdoor living.



**WATERPROOF DESIGN**  
Integrated drainage system keeps rainwater away and your space dry.



**SMART CONTROL**  
Electric or manual operation with remote control for convenience.



**SUPPORT CUSTOMIZATION**  
Multiple sizes and configurations available to meet your needs.

## DESIGNED FOR EVERY SPACE. BUILT FOR EVERY MOMENT.

From private retreats to commercial spaces, Parallelism pergolas enhance the way you live, work, and connect outdoors.

Explore the possibilities.



### RESIDENTIAL PATIOS

Create a stylish outdoor living space perfect for relaxing, dining, and entertaining.



### POOL AREAS

Enjoy shade and comfort by the pool while adding a sleek, modern touch.



### OUTDOOR DINING

Elevate any meal with a comfortable, elegant setting.



### COMMERCIAL SPACES

Perfect for restaurants, cafes, hotels, and rooftop lounges.



### OFFICE & CORPORATE

Enhance employee wellness and create inviting outdoor break or meeting areas.



### WELLNESS & FITNESS

Provide shade and comfort for outdoor gyms, yoga studios, and wellness centers.



### EDUCATION

Create functional outdoor learning and gathering spaces.



### EVENTS & HOSPITALITY

Ideal for weddings, private events, and hospitality venues.



## ENHANCE EVERY EXPERIENCE OUTDOORS

Built with precision. Designed for life. Parallelism pergolas bring beauty, comfort, and value to any environment.



#### COMFORT

Adjustable louvers let you control sunlight and airflow for year-round enjoyment.



#### DURABILITY

Engineered with high-quality aluminum and finishes to withstand the elements.



#### AESTHETICS

Clean lines and modern designs elevate the look of any space.



#### VALUE

Adds functional space and increases the value of your property.



#### HIGH LOAD CAPACITY

Engineered to withstand heavy loads up to 100 kg/m<sup>2</sup>.



#### WIND RESISTANCE

Withstands wind speeds up to 120km/h for safe outdoor living.



#### WATERPROOF DESIGN

Integrated drainage system keeps rainwater away and your space dry.



#### SMART CONTROL

Electric or manual operation with remote control for convenience.



#### SUPPORT CUSTOMIZATION

Multiple sizes and configurations available to meet your needs.

## REAL SPACES. REAL IMPACT.

Discover how Parallelism pergolas transform outdoor spaces into beautiful, functional environments. Each project is a testament to our commitment to quality, innovation, and design excellence.



### BUILT WITH PRIDE

Every pergola is engineered, fabricated, and finished to the highest standards.



### DESIGNED AROUND YOU

Custom sizes, finishes, and features tailored to your vision and needs.



**PRIVATE RESIDENCE**  
Miami, Florida  
Custom 5.5m x 4.5m Pergola with LED Lighting



### LUXURY HOTEL ROOFTOP

San Diego, California

Multiple Pergolas with Integrated Lighting & Wind Sensors



### RESTAURANT TERRACE

Austin, Texas

Custom 7m x 5m Pergola with Adjustable Louvers



### CORPORATE ROOFTOP LOUNGE

Chicago, Illinois

Dual Pergola Structures with Smart Controls



### POOLSIDE RETREAT

Phoenix, Arizona

4m x 4m Pergola with Waterproof Design



### EDUCATIONAL CAMPUS

Toronto, Ontario

Outdoor Study Area with Weather Protection

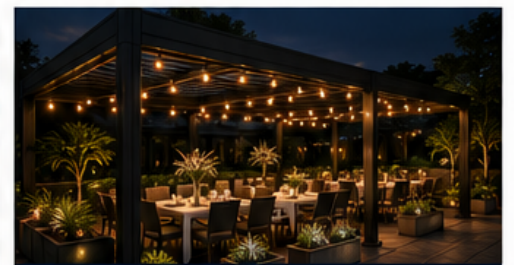

### EVENT VENUE

Nashville, Tennessee

Large-Scale Pergola with Ambient Lighting

## OUR IMPACT

Trusted by homeowners, businesses, and architects across North America.



**2,500+**

PROJECTS COMPLETED



**1,800+**

SATISFIED CLIENTS



**10+**

YEARS OF EXPERIENCE



**30+**

CITIES SERVED



**HIGH LOAD CAPACITY**  
Engineered to withstand heavy loads up to 100 kg/m<sup>2</sup>.



**WIND RESISTANCE**  
Withstands wind speeds up to 120km/h for safe outdoor living.



**WATERPROOF DESIGN**  
Integrated drainage system keeps rainwater away and your space dry.



**SMART CONTROL**  
Electric or manual operation with remote control for convenience.



**SUPPORT CUSTOMIZATION**  
Multiple sizes and configurations available to meet your needs.

15

THANK YOU

BUILT FOR LIFE.  
DESIGNED FOR MEMORIES.



Parallelism  
architectural & building supply

# THANK YOU

FOR CONSIDERING PARALLELISM.

We appreciate the opportunity to be a part of your project.

At Parallelism, we are committed to delivering exceptional products, thoughtful service, and spaces that stand the test of time.



READY TO GET STARTED?

Our team is here to bring your outdoor vision to life.



+1 (888) 123-4567



info@parallelism.com



www.parallelism.com



1234 Building Way, Suite 100  
Los Angeles, CA 90017  
United States



WE DON'T JUST BUILD PERGOLAS.  
WE BUILD BETTER SPACES.



**CUSTOM SOLUTIONS**  
Tailored to your style, space, and needs.



**BUILT TO LAST**  
Premium materials. Expert craftsmanship.



**DEDICATED SUPPORT**  
We're with you every step of the way.



**QUALITY YOU CAN TRUST**  
Engineered for performance. Designed for life.



**RELAX**  
Unwind in comfort.



**ENTERTAIN**  
Gather. Celebrate. Connect.



**WORK & FOCUS**  
Create inspiring outdoor environments.



**LIVE BETTER**  
Thoughtfully designed for everyday living.



DESIGNED FOR LIFE.  
BUILT FOR MEMORIES.

Whether it's a quiet morning, a productive afternoon, or a memorable evening—Parallelism pergolas help you make the most of every moment outdoors.

*Let's build better spaces. Together.*

PARALLEL LINES. BETTER SPACES.



www.parallelism.com



info@parallelism.com



+1 (888) 123-4567